

# GADNIC

## MANUAL DE USUARIO

### CASA EXTERIOR PARA GATOS CON CALEFACCIÓN



**PETLIT09**

## INDICE

ESPAÑOL.....	03
ENGLISH.....	07
PORTUGUÊS.....	11

# INSTRUCCIONES DE USO

## CASA PARA GATOS CALEFACTADA PARA EXTERIORES PETLIT09









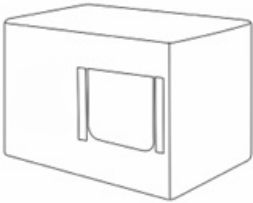
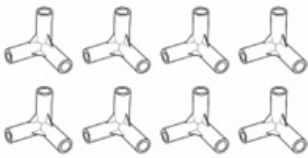
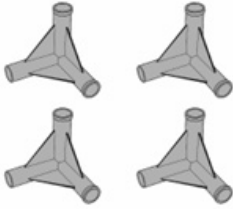
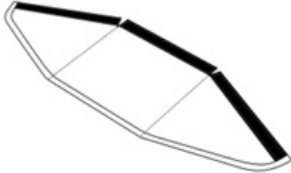

LEA ATENTAMENTE LAS INSTRUCCIONES ANTES DE SU USO. RESERVE EL MANUAL  
PARA FUTURAS CONSULTAS

# Información importante

Siga cuidadosamente cada paso de las instrucciones.

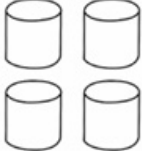
Conserve esta información para futura referencia.

## LISTA DE PIEZAS

<b>A</b> x1 	<b>B</b> x8 	<b>C</b> x4 	<b>D</b> x1 
<b>E</b> x4 	<b>F</b> x4 	<b>G</b> x4 	<b>H</b> x4 
<b>I</b> x4 	<b>J</b> x2 	<b>K</b> x2 	<b>L</b> x1 

# Instrucciones de armado

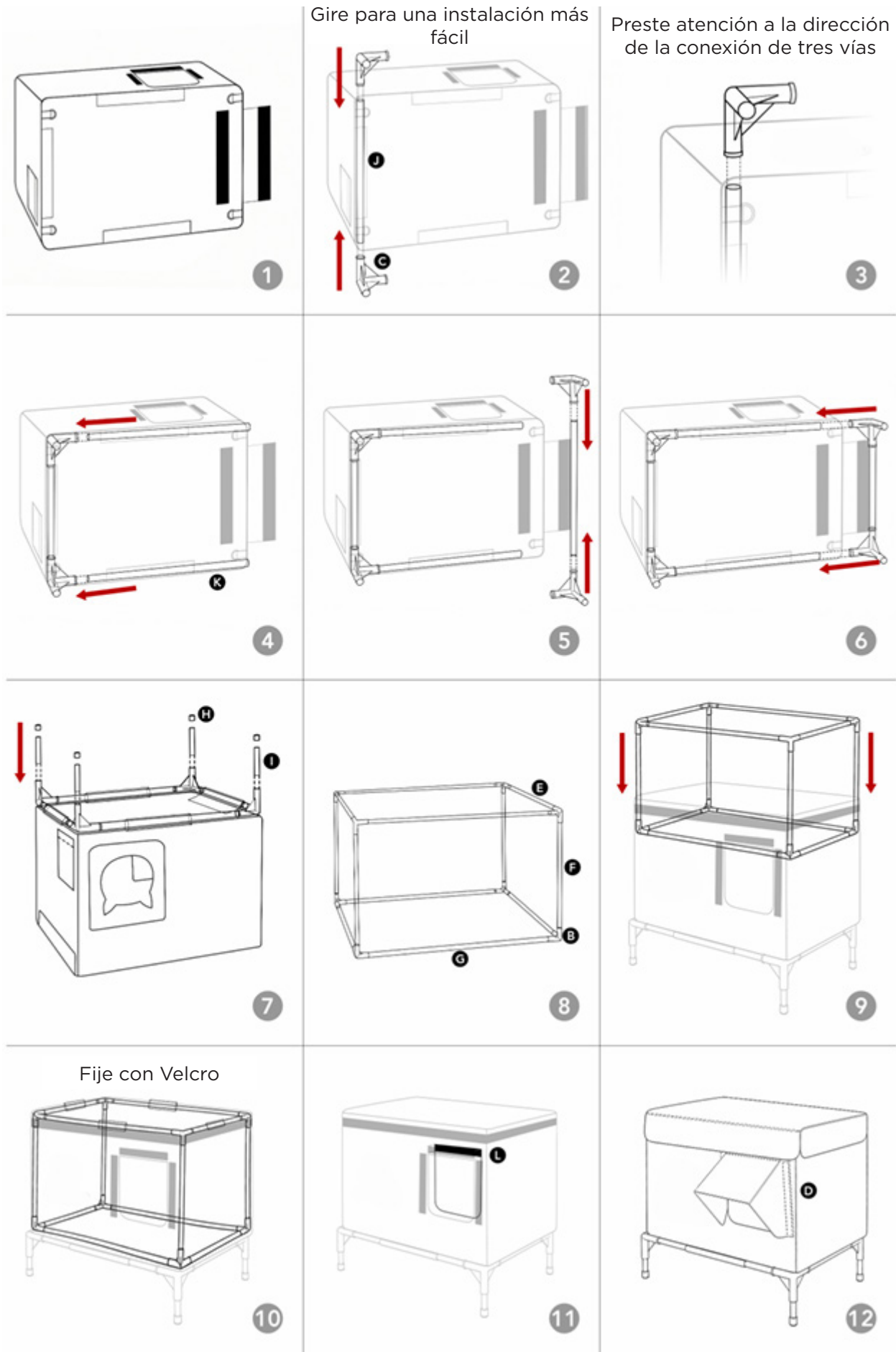

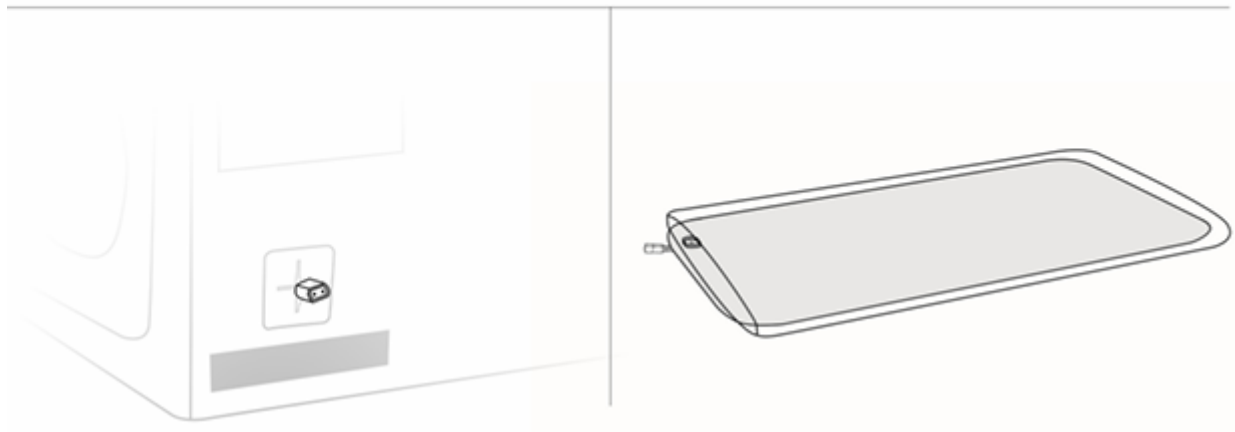
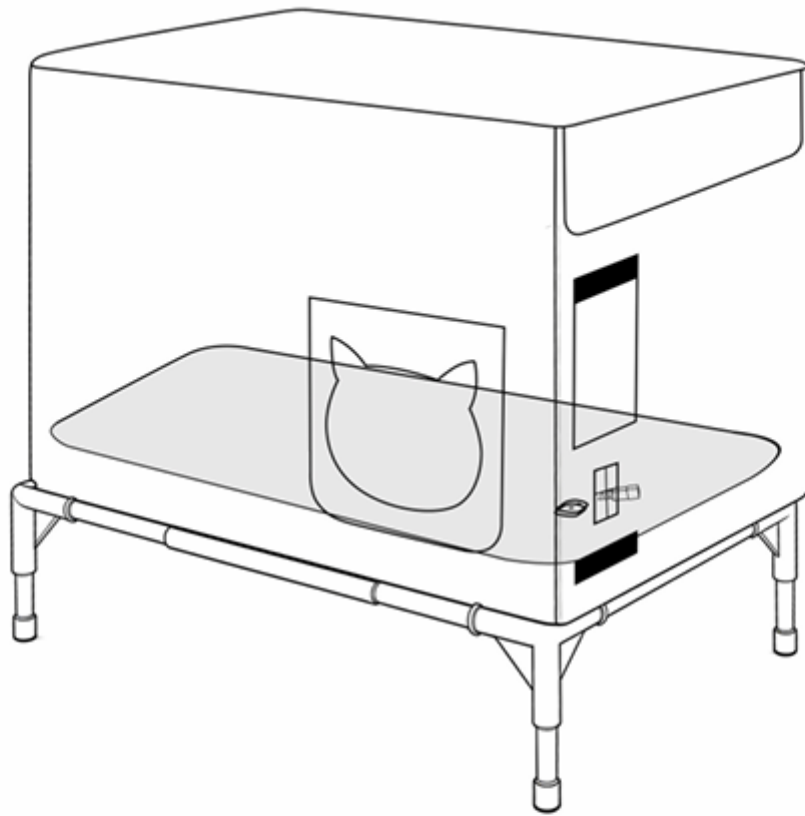

## Configuración de la almohadilla térmica y la cubierta (si corresponde)

**Solo para versiones con calefacción:**

- Coloque la almohadilla térmica plana dentro de la casa para gatos.
- Pase el cable a través de la salida lateral.
- Cubra toda la estructura con la capa exterior impermeable.
- No doble ni arrugue la almohadilla térmica. Úsela siempre plana.

# INSTRUCTIONS FOR USE

## OUTDOOR HEATED CAT HOUSE PETLIT09









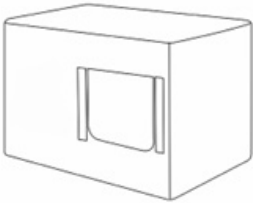
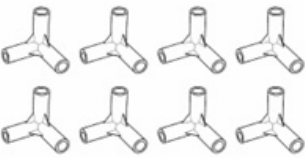
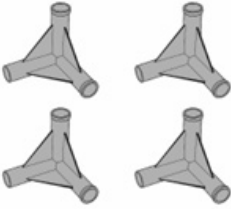
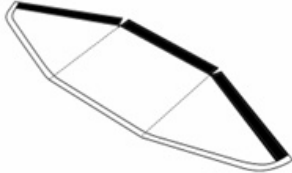

PLEASE READ THE INSTRUCTIONS CAREFULLY BEFORE USE. KEEP THE MANUAL  
FOR FUTURE REFERENCE

# Important information

Follow each step of the instruction carefully.

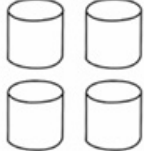
Keep this information for further reference.

## PARTS LIST

<b>A</b> x1 	<b>B</b> x8 	<b>C</b> x4 	<b>D</b> x1 
<b>E</b> x4 	<b>F</b> x4 	<b>G</b> x4 	<b>H</b> x4 
<b>I</b> x4 	<b>J</b> x2 	<b>K</b> x2 	<b>L</b> x1 

# Assembly instructions

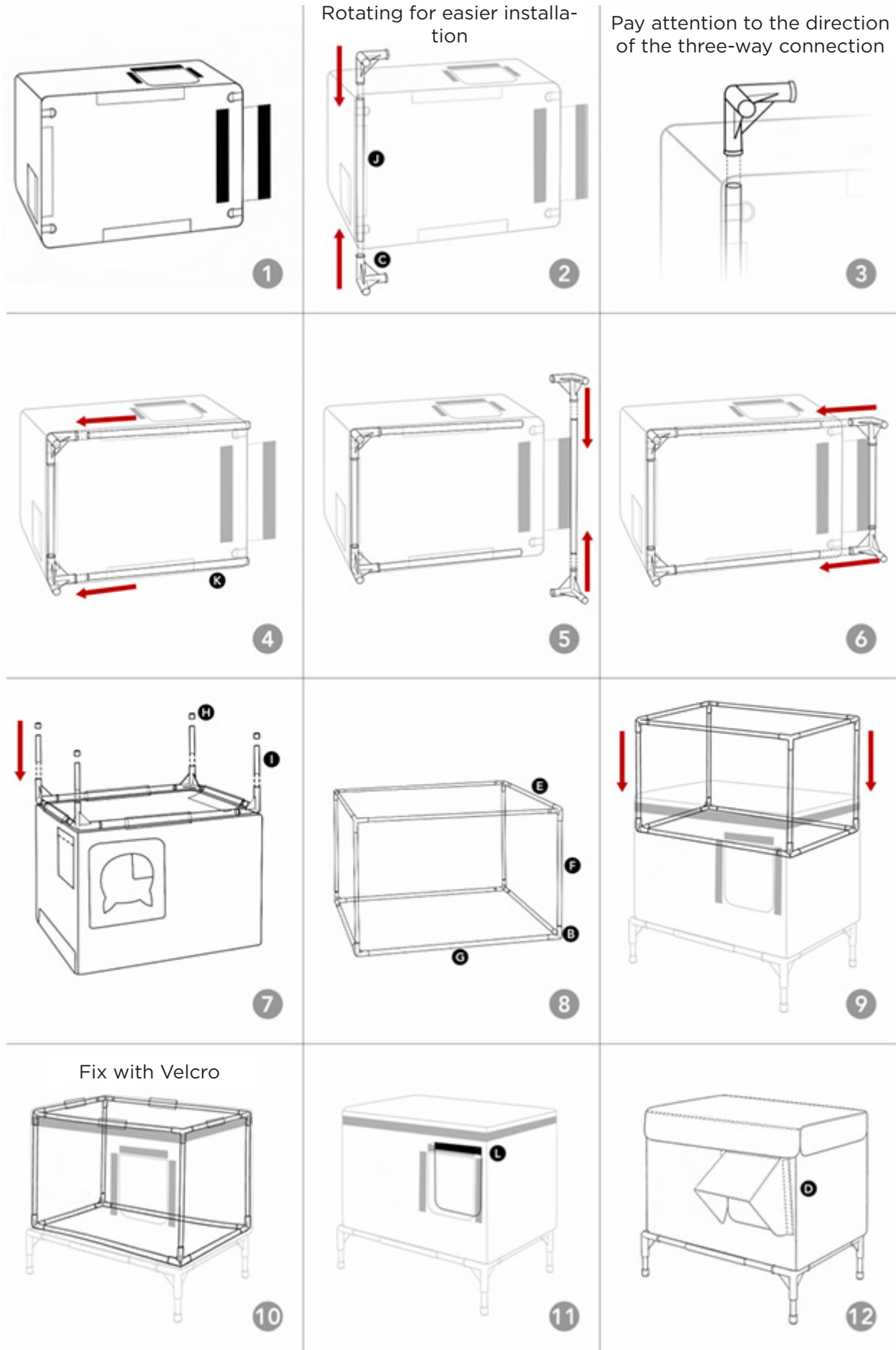

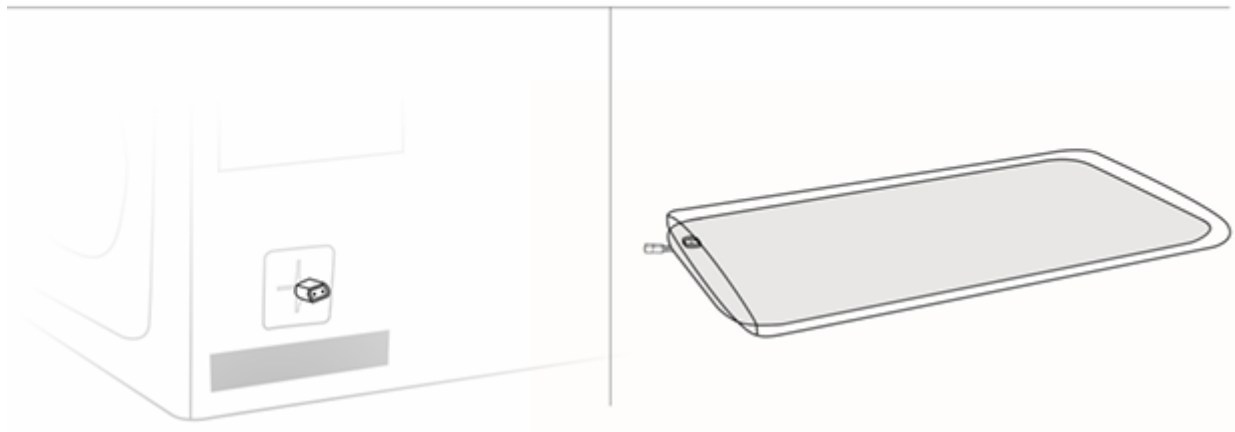
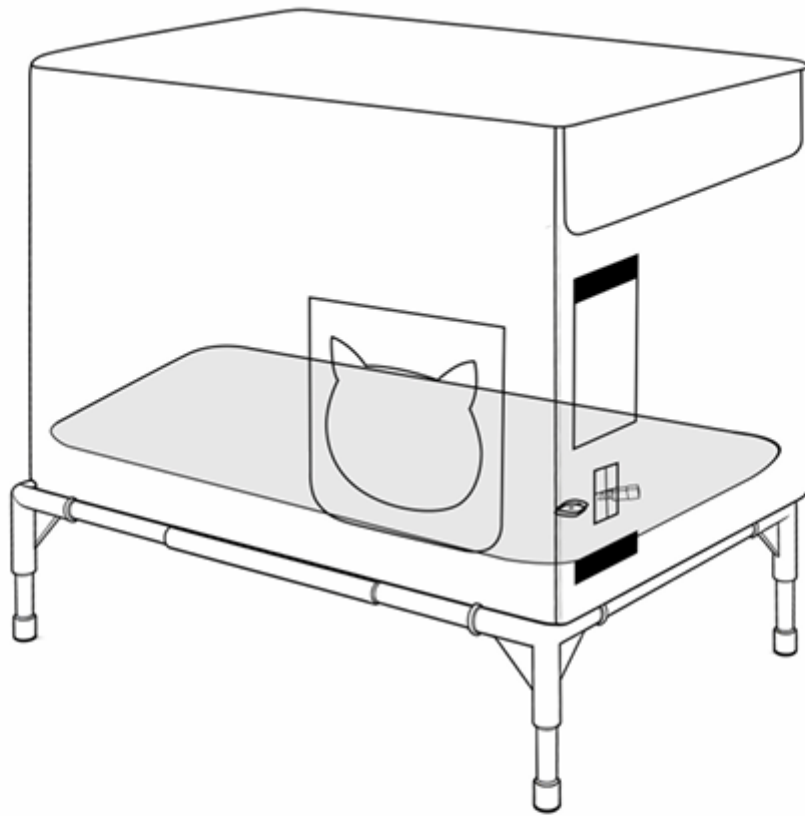

## Heating Pad & Cover Setup (If Applicable)

**For heated versions only:**

- Lay the heating pad flat inside the cat house.
- Thread the cord through the side outlet.
- Cover the entire structure with the waterproof outer layer.
- Do not fold or crease the heating pad. Always use flat.

# INSTRUÇÕES DE USO

## CASINHA AQUECIDA PARA GATOS AO AR LIVRE PETLIT09









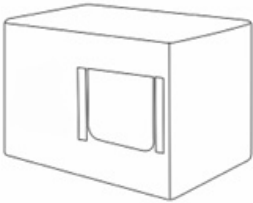
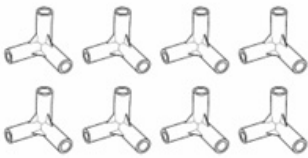
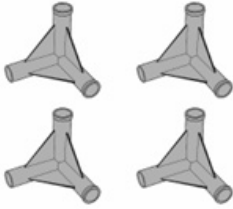
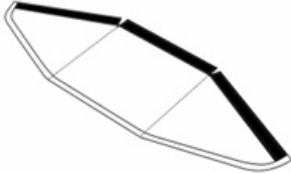

LEIA ATENTAMENTE AS INSTRUÇÕES ANTES DE USAR. GUARDE O MANUAL PARA FUTURAS CONSULTAS

# Informações importantes

Siga cuidadosamente cada passo das instruções.

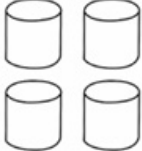
Guarde estas informações para referência futura.

## LISTA DE PEÇAS

<b>A</b> x1 	<b>B</b> x8 	<b>C</b> x4 	<b>D</b> x1 
<b>E</b> x4 	<b>F</b> x4 	<b>G</b> x4 	<b>H</b> x4 
<b>I</b> x4 	<b>J</b> x2 	<b>K</b> x2 	<b>L</b> x1 

# Instruções de montagem

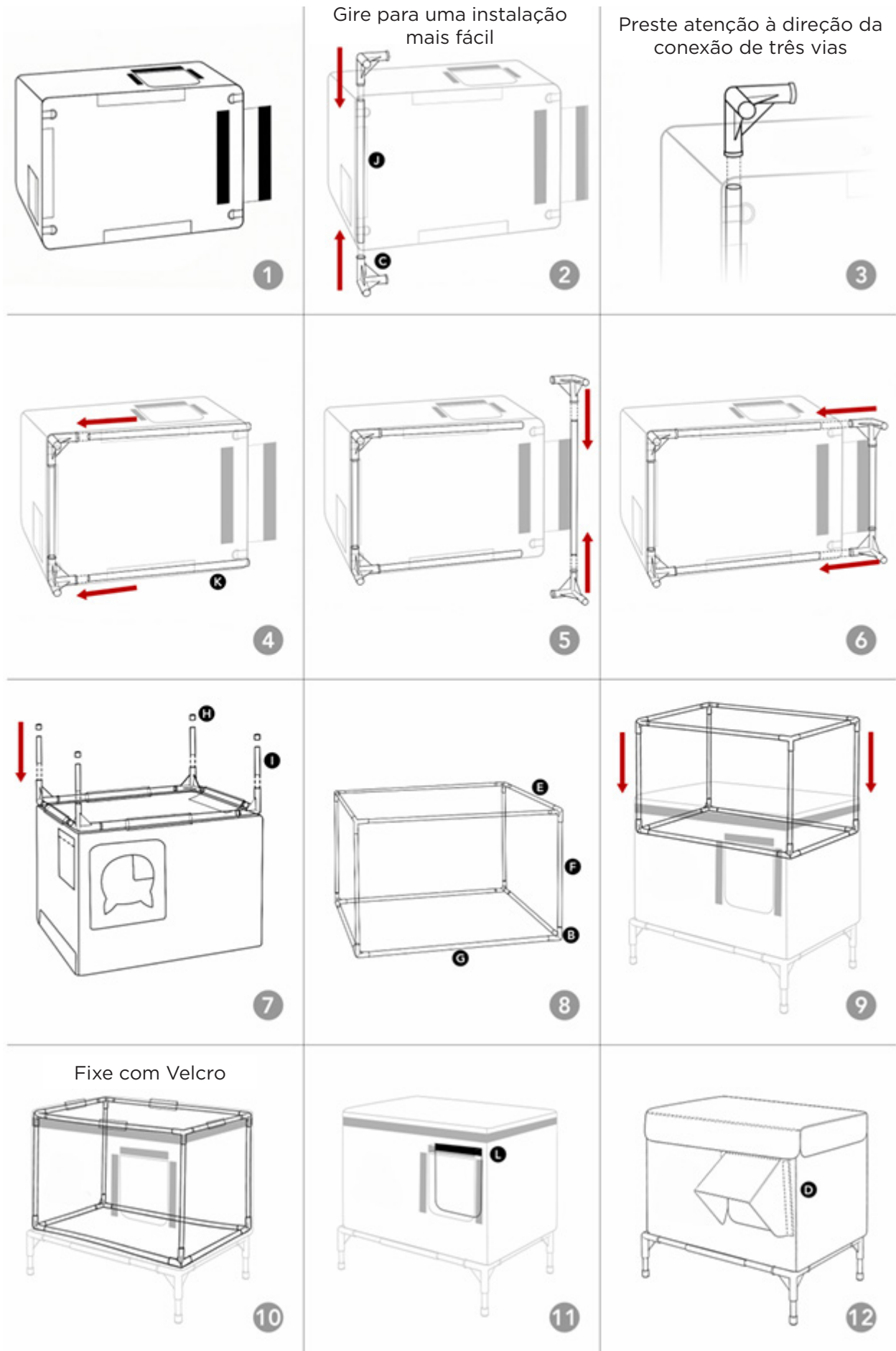

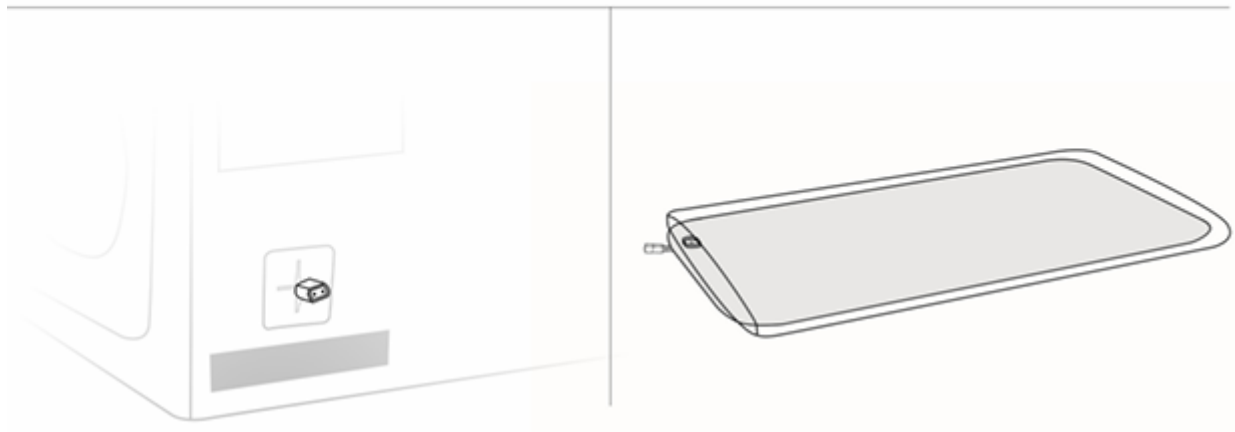
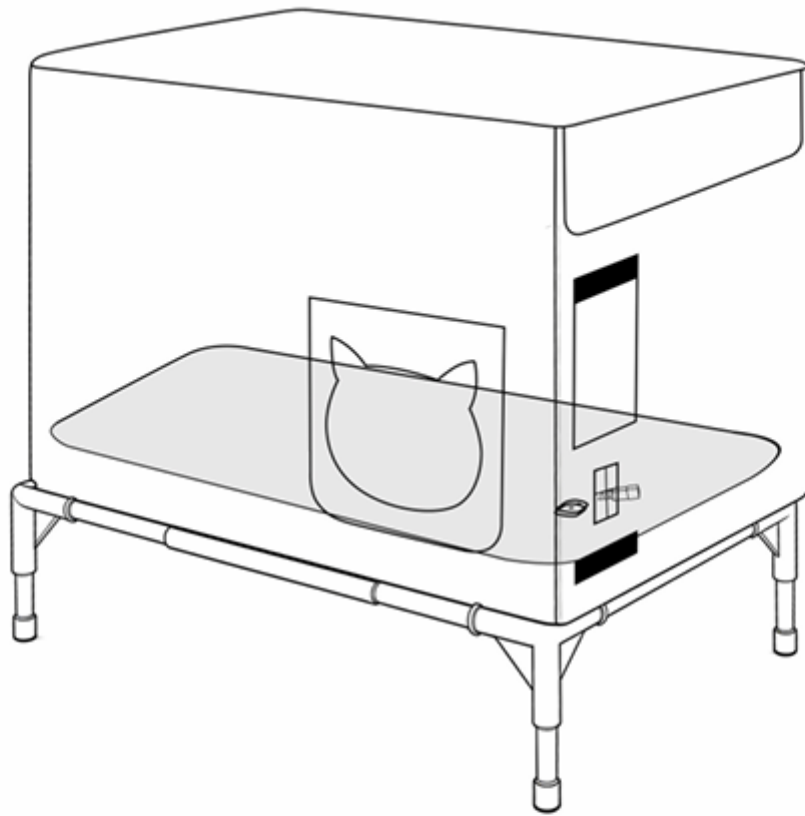

## Configuração da almofada de aquecimento e cobertura (se aplicável)

Apenas para versões com aquecimento:

- Coloque a almofada de aquecimento plana dentro da casa para gatos.
- Passe o cabo pela saída lateral.
- Cubra toda a estrutura com a camada externa impermeável.
- Não dobre nem vinque a almofada de aquecimento. Use sempre plana.



## ¿Necesitás ayuda?

Ingresa a nuestro soporte técnico escaneando el QR o escribinos por nuestros canales oficiales.



**11 6260 1114 (sólo texto)**



**serviciotecnico@bidcom.com.ar**



**www.bidcomservice.com.ar**

**Bidcom**  
SERVICE

